









## 16 Verriegelungspunkte + Türblatt 76mm









### Zertifikate / Prüfungen



### geprüfte Zusatzoptionen

-  Brandschutz EI<sub>1</sub>30-C5
-  Schallschutz
-  Sicherheitsglas/Glasausschnitt
-  Überhöhe
-  Oberlichte
-  Altbau Nachbildung mit Zierrahmen

### RIHA Vorteile

-  kaum Verlust der Durchgangslichte
-  kein Entfernen des alten Türstocks notwendig
-  kaum Schmutz bei Montage
-  Montagezeit ca. 2 Stunden
-  Montage durch ein zertifiziertes Montageteam
-  Made in Austria

#### HALB-Ummantelung

Sicherheitszarge mit Abschlussprofil am bestehenden Türstock aus Metall/Holz  
 Alter Türstock bleibt außen sichtbar



Video zur Montage

#### HALB-Ummantelung Metallstock

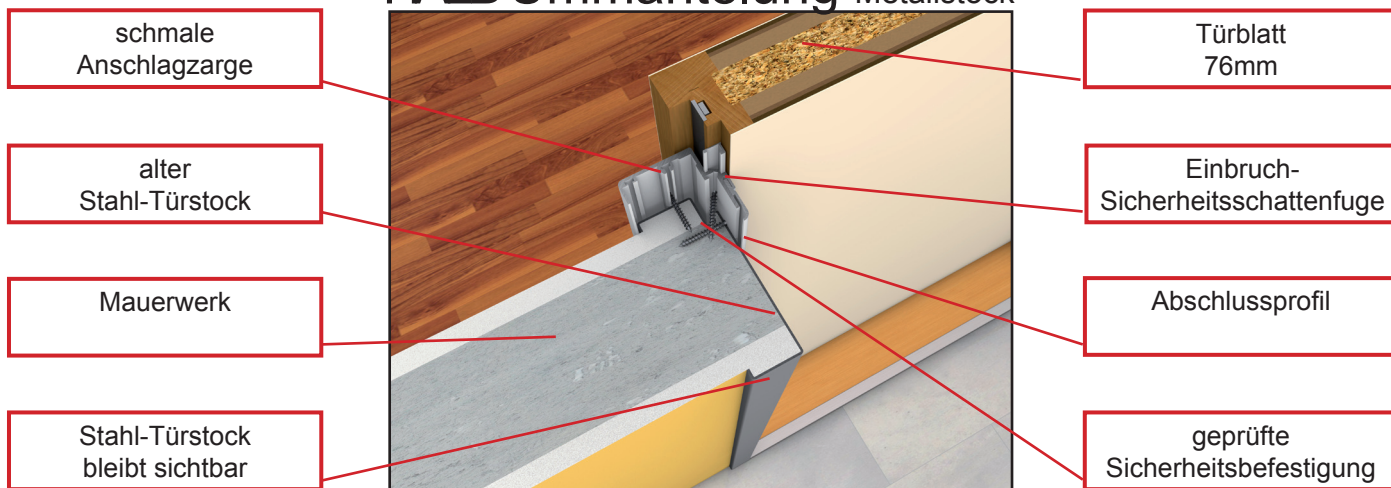

#### VOLL-Ummantelung

Sicherheitszarge mit Futterplatte und Außenschale  
 Alter Türstock wird durch neue Aluzarge vollkommen verdeckt



Video zur Montage

#### VOLL-Ummantelung Holzstock

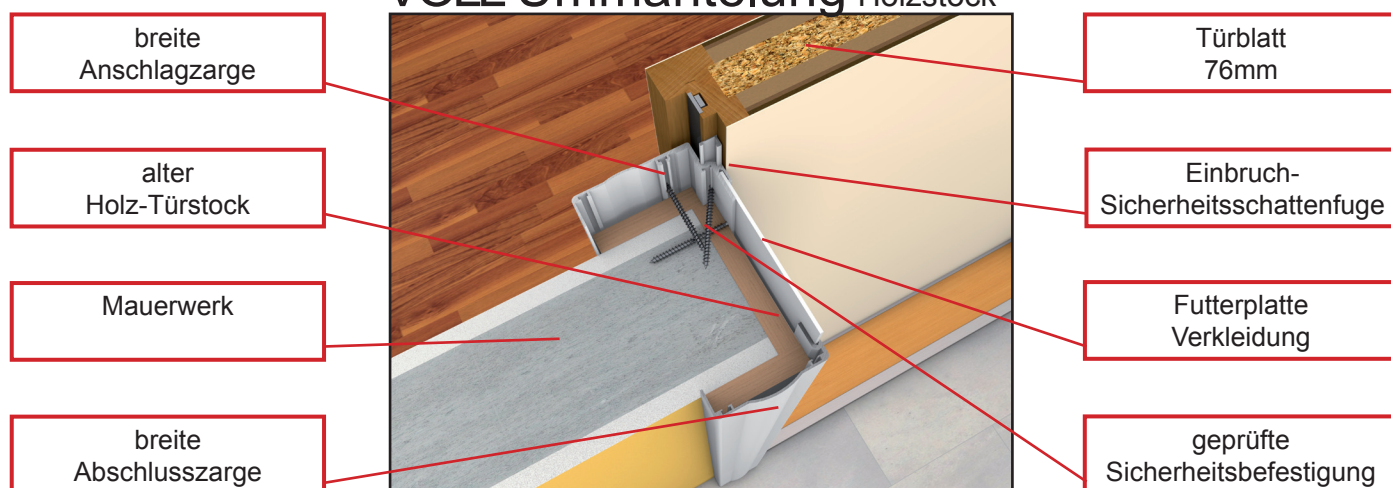

RIHA Ummantelungszargen sind so konstruiert, dass der Verlust an bestehender Durchgangslichte (Breite des bestehenden Türstockes) möglichst gering ist. Pro Seite sind das je nach lotrechter Ausrichtung des bestehenden Türstockes ca. 10-14mm.